

NPA-CP

Pendant control station



Pendant station for **direct control** of industrial machines. Sturdy and handy, NPA-CP is specifically designed for heavy duty in industrial environments.

FEATURES

- The cable sleeve can be angled up to 20° to give the operator the best view of all the control elements and enable a natural, comfortable working position.
- Rubber pushbuttons with symbol disks to ensure protection against dust and prevent jamming when the control station is used in harsh environments.
- Two-colour moulded pushbutton disks to guarantee clear reading and wear resistance
- The emergency stop mushroom pushbutton complies with standard EN 418.
- Mechanical life of switches: 1 million operations.
- IP protection degree: NPA-CP is classified IP65.
- Extreme temperature resistance: -25°C to +70°C.
- All materials and components used are wear resistant and guarantee protection of the unit against water and dust.

OPTIONS

- Available in configuration from 2 to 8 actuators.
- 1 or 2 speed two-pole switches or 1 speed three-pole switches, with or without brake contact, for direct control.
- Mechanical interlock to prevent simultaneous operation of opposite functions.

CERTIFICATIONS

- CE marking and EAC certification.

Fill in the "request form" for accurate product configuration.

CERTIFICATIONS

Conformity to Community Directives	2014/35/UE Low Voltage Directive
	2006/42/CE Machinery Directive
Conformity to CE Standards	EN 60204-1 Safety of machinery - Electrical equipment of machines
	EN 60947-1 Low-voltage switchgear and controlgear
	EN 60947-3 Low-voltage switchgear and controlgear - Switches, disconnectors, switch-disconnectors and fuse-combination units
	EN 60529 Degrees of protection provided by enclosures
Markings and homologations	EN 418 Safety of machinery - Emergency stop equipment, functional
	CE EAC

GENERAL TECHNICAL SPECIFICATIONS

Ambient temperature	Storage -40°C/+70°C
	Operational -25°C/+70°C
IP protection degree	IP 65
Insulation category	Class II
Cable entry	2÷6 buttons: rubber cable sleeve (Ø 10÷18 mm)
	8 buttons: rubber cable sleeve (Ø 17÷26 mm)
Operating positions	Any position

TECHNICAL SPECIFICATIONS OF THE SWITCHES

Code	PRSL0458PI	PRSL0459PI	PRSL0460PI
Utilisation category	AC 3 - AC 4	AC 3 - AC 4	AC 3 - AC 4
Rated operational current		10 A	
Rated operational voltage		400 Vac	
Rated operational power		2.2 kW	
Rated thermal current		20 A	
Rated insulation voltage		660 Vac	
Brake operating contact	-	100 Vac, 0.7 A, L/R=100 ms	-
Mechanical life	1x10 ⁶ operations		
Connections	Screw-type terminals with self-lifting pads		
Wires	1x2.5 mm ² , 2x1.5 mm ²		
Tightening torque	0.8 Nm		
Switch type	1 speed, two-pole double switch	1 speed, two-pole double switch, with brake contact	2 speeds, two-pole double switch
Scheme			
Markings and homologations	CE EAC		

Code	PRSL0461PI	PRSL0471PI
Utilisation category	AC 3 - AC 4	AC 3 - AC 4
Rated operational current	10 A	
Rated operational voltage	400 Vac	
Rated operational power	2.2 kW	
Rated thermal current	20 A	
Rated insulation voltage	660 Vac	
Brake operating contact	100 Vac, 0.7 A, L/R=100 ms	-
Mechanical life	1x10 ⁶ operations	
Connections	Screw-type terminals with self-lifting pads	
Wires	1x2.5 mm ² , 2x1.5 mm ²	
Tightening torque	0.8 Nm	
Switch type	2 speeds, two-pole double switch, with brake contact	1 speed, three-pole double switch
Scheme		
Markings and homologations	CE EAC	

Code	PRSL0472PI	PRSL0508PI
Utilisation category	AC 3 - AC 4	AC 23B
Rated operational current	10 A	
Rated operational voltage	400 Vac	
Rated operational power	2.2 kW	
Rated thermal current	20 A	
Rated insulation voltage	660 Vac	
Brake operating contact	100 Vac, 0.7 A, L/R=100 ms	-
Mechanical life	1x10 ⁶ operations	
Connections	Screw-type terminals with self-lifting pads	
Wires	1x2.5 mm ² , 2x1.5 mm ²	
Tightening torque	0.8 Nm	
Switch type	1 speed, three-pole double switch, with brake contact	1 speed, three-pole single switch
Scheme		
Markings and homologations	CE EAC	

OVERALL DIMENSIONS (mm)

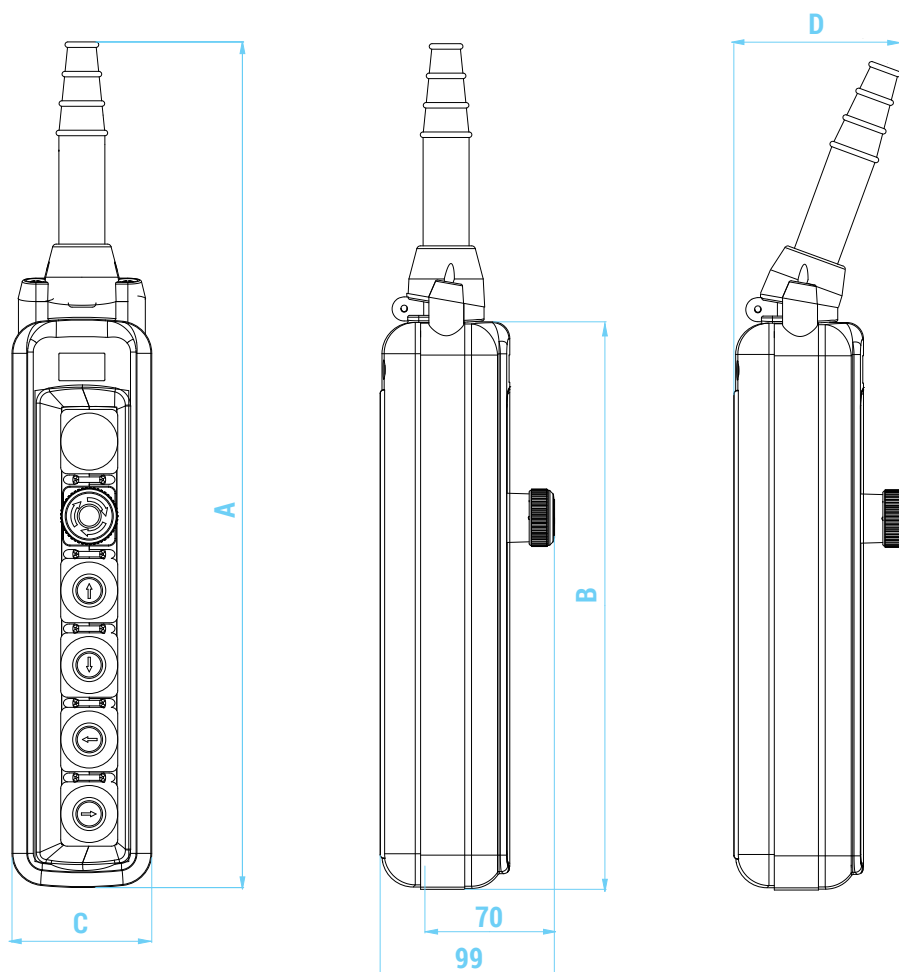









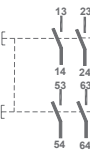

No. of actuators	Dimensions (mm)			
	A	B	C	D
2	292	140	76	87
3	333	181	76	87
4	372	222	76	87
6	459	307	76	87
8	605	393	83	116

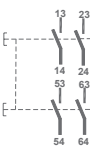



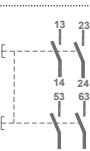







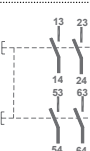

STANDARD CONTROL STATIONS



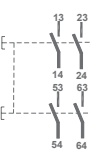

Standard control stations are equipped with cable sleeve, hook and mechanical interlock between opposite functions pushbuttons.

3 actuators



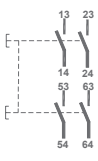

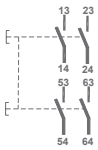

PF30030001			PF30030003		
Switch scheme	Switch type	Actuator type	Switch scheme	Switch type	Actuator type
	PRSL0508PI 3NC 1 speed	Latched mushroom pushbutton		PRSL0508PI 3NC 1 speed	Latched mushroom pushbutton
	PRSL0471PI 1 speed three-pole	Pushbutton  Pushbutton 		PRSL0460PI 2 speeds two-pole	Pushbutton  Pushbutton 
PF30030004					
Switch scheme	Switch type	Actuator type			
	PRSL0508PI 3NC 1 speed	Latched mushroom pushbutton			
	PRSL0458PI 1 speed two-pole	Pushbutton  Pushbutton 			



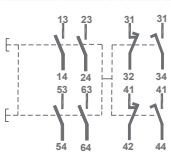

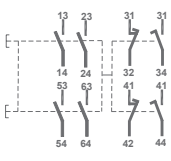

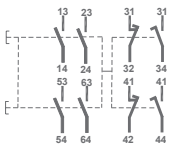
6 actuators



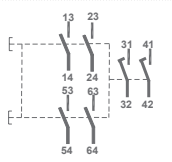

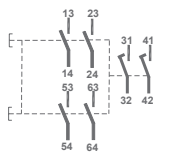

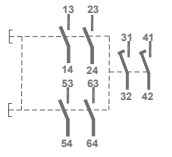



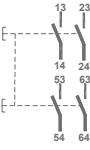

PF30060002			PF30060004		
Switch scheme	Switch type	Actuator type	Switch scheme	Switch type	Actuator type
	PRSL0508PI 3NC 1 speed	Latched mushroom pushbutton		PRSL0508PI 3NC 1 speed	Latched mushroom pushbutton
-	-	Blanking plug	-	-	Blanking plug
	PRSL0460PI 2 speeds two-pole	Pushbutton  Pushbutton 		PRSL0471PI 1 speed three-pole	Pushbutton  Pushbutton 
	PRSL0460PI 2 speeds two-pole	Pushbutton  Pushbutton 		PRSL0471PI 1 speed three-pole	Pushbutton  Pushbutton 

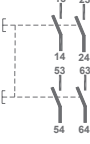
PF30060019		
Switch scheme	Switch type	Actuator type
	PRSL0508PI 3NC 1 speed	Latched mushroom pushbutton
-	-	Blanking plug
	PRSL0458PI 1 speed two-pole	Pushbutton 
		Pushbutton 
	PRSL0458PI 1 speed two-pole	Pushbutton 
		Pushbutton 

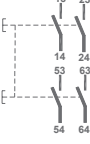
8 actuators

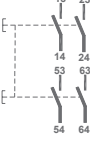
PF30080001		
Switch scheme	Switch type	Actuator type
	PRSL0508PI 3NC 1 speed	Latched mushroom pushbutton
-	-	Blanking plug
	PRSL0460PI 2 speeds two-pole	Pushbutton 
		Pushbutton 
	PRSL0460PI 2 speeds two-pole	Pushbutton 
		Pushbutton 
	PRSL0460PI 2 speeds two-pole	Pushbutton 
		Pushbutton 

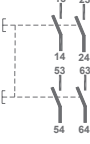
PF30080010		
Switch scheme	Switch type	Actuator type
	PRSL0508PI 3NC 1 speed	Latched mushroom pushbutton
-	-	Blanking plug
	PRSL0471PI 1 speed three-pole	Pushbutton 
		Pushbutton 
	PRSL0471PI 1 speed three-pole	Pushbutton 
		Pushbutton 
	PRSL0471PI 1 speed three-pole	Pushbutton 
		Pushbutton 

PF30080022		
Switch scheme	Switch type	Actuator type
	PRSL0508PI 3NC 1 speed	Latched mushroom pushbutton
-	-	Blanking plug
	PRSL0458PI 1 speed two-pole	Pushbutton 
	PRSL0458PI 1 speed two-pole	Pushbutton 
	PRSL0458PI 1 speed two-pole	Pushbutton 
	PRSL0458PI 1 speed two-pole	Pushbutton 
	PRSL0458PI 1 speed two-pole	Pushbutton 
	PRSL0458PI 1 speed two-pole	Pushbutton 

ASSEMBLY DRAWING

2

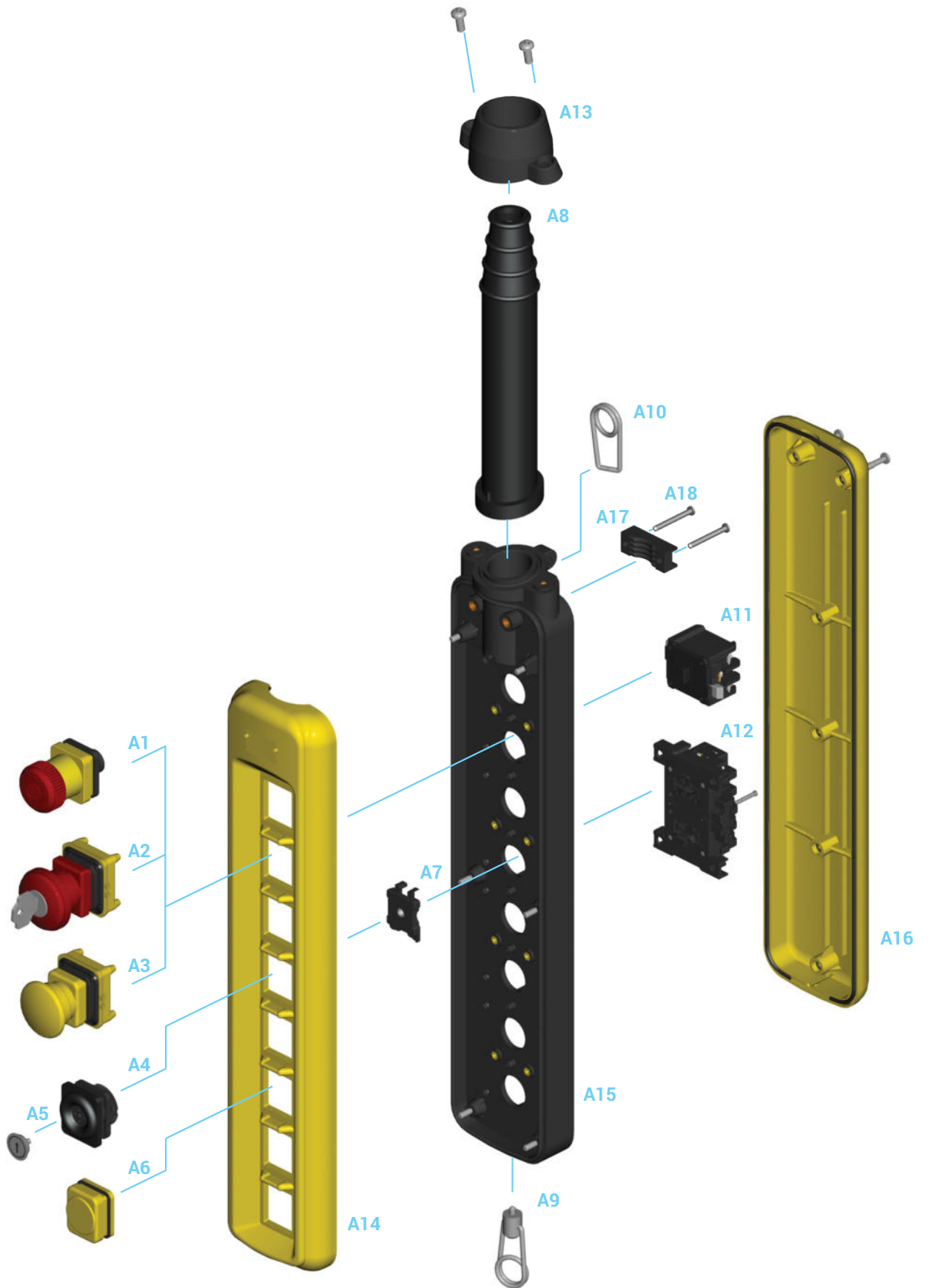



Refer to the following tables for descriptions of components: "Switches", "Actuators", "Mushroom pushbuttons" and "Accessories".

Ref.	Drawing	Description	Scheme	Code
		1 speed, two-pole double switch		PRSL0458PI
		1 speed, two-pole double switch, with brake contact		PRSL0459PI
		2 speeds, two-pole double switch		PRSL0460PI
A12		2 speeds, two-pole double switch, with brake contact		PRSL0461PI
		1 speed, three-pole double switch		PRSL0471PI
		1 speed, three-pole double switch, with brake contact		PRSL0472PI
A11		1 speed, three-pole single switch, for mushroom pushbutton		PRSL0508PI



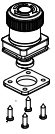

Actuators

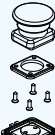
Ref.	Drawing	Description	Code
A6		Blanking plug	PRSL0517PI
A5		Disk for dust-tight pushbutton	PRTA_----- See standard disk
A4		Dust-tight pushbutton	PRSL0550PI

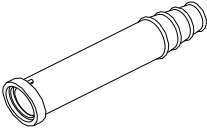

Mushroom pushbuttons

Ref.	Drawing	Description	Code
A1		Latched mushroom pushbutton for emergency stop	PRSL0600PI
A2		Key mushroom pushbutton (yellow)	PRSL0520PI
A2		Key mushroom pushbutton (red)	PRSL0520RO
A3		Impulse mushroom pushbutton	PRSL0512PI

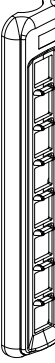
Accessories

Ref.	Drawing	Description	Code
A7		Mechanical interlock	PRSL7817PI
A8		Cable sleeve for 2 - 6 button units	PRG00100PE
A8		Cable sleeve for 8 button units	PRG00105PE
A9		Wire fixing	PRT06626PE
A10		Hook	PRGA0001PE
A13		Cable sleeve holder - NPA-CP 2-6 buttons	PRSL9735PI
A13		Cable sleeve holder - NPA-CP 8 buttons	PRSL9740PI
A14		Upper cover with tightening rubber - NPA-CP 2 buttons	PRSL5810PI
		Upper cover with tightening rubber - NPA-CP 3 buttons	PRSL5838PI
		Upper cover with tightening rubber - NPA-CP 4 buttons	PRSL5815PI
		Upper cover with tightening rubber - NPA-CP 6 buttons	PRSL5820PI
		Upper cover with tightening rubber - NPA-CP 8 buttons	PRSL5825PI

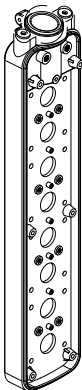
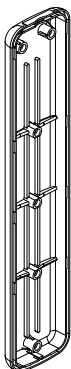
Accessories

Ref.	Drawing	Description	Code
A15		Central section - NPA-CP 2 buttons	PRSL5813PI
		Central section - NPA-CP 3 buttons	PRSL5841PI
		Central section - NPA-CP 4 buttons	PRSL5818PI
		Central section - NPA-CP 6 buttons	PRSL5823PI
		Central section - NPA-CP 8 buttons	PRSL5828PI
A16		Lower enclosure, tightening rubber, screws - NPA-CP 2 buttons	PRSL5812PI
		Lower enclosure, tightening rubber, screws - NPA-CP 3 buttons	PRSL5840PI
		Lower enclosure, tightening rubber, screws - NPA-CP 4 buttons	PRSL5817PI
		Lower enclosure, tightening rubber, screws - NPA-CP 6 buttons	PRSL5822PI
		Lower enclosure, tightening rubber, screws - NPA-CP 8 buttons	PRSL5827PI
A17		Cable clamp	PRSL9210AU
A18		Screws for cable clamp	PRVI0089PE

Standard disks



