

CARATTERISTICHE SPECIFICATION

Pewag Winner chain slings can be supplied assembled with connecting links or with clevis accessories. The usual tolerance of length L is +2 chain pitches.

ORDER TEXT

Specific information related to the capacity required, lifting points, uneven distribution of the load in case of more chain legs, angle between the legs of the sling, abnormal temperatures.

Example of order

Pewag Winner - 13 mm - double-leg chain sling with master link and eye hook - length 1.600 mm
Cod. 2AH 13 L= 1.600 mm.

I tiranti Pewag Winner possono essere forniti con accessori di tipo a occhio, con maglie di giunzione o con accessori di tipo a perno.
La normale tolleranza della lunghezza L è pari a 2 passi di catena.

DATI NECESSARI PER L'ORDINE

Informazioni inerenti la portata totale richiesta, punti di ancoraggio, distribuzione non uniforme del carico nel caso di tiranti a più bracci, ampiezza dell'angolo tra i bracci di catena, temperature anormali.

Esempio di ordine

Tirante di catena Pewag Winner d. 13 mm a 2 bracci con campanella e 2 ganci ad occhio alle estremità lunghezza L=1600 mm.
Cod. del tirante: 2AH 13 L=1600 mm.



I codici in **nero** indicano accessori terminali a occhio.
Black codes mean eye type bottom hooks

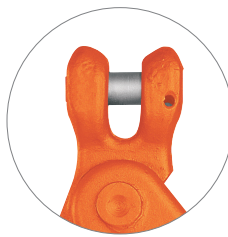

I codici in **blu** indicano accessori terminali a perno.
Blue codes mean clevis type bottom hooks

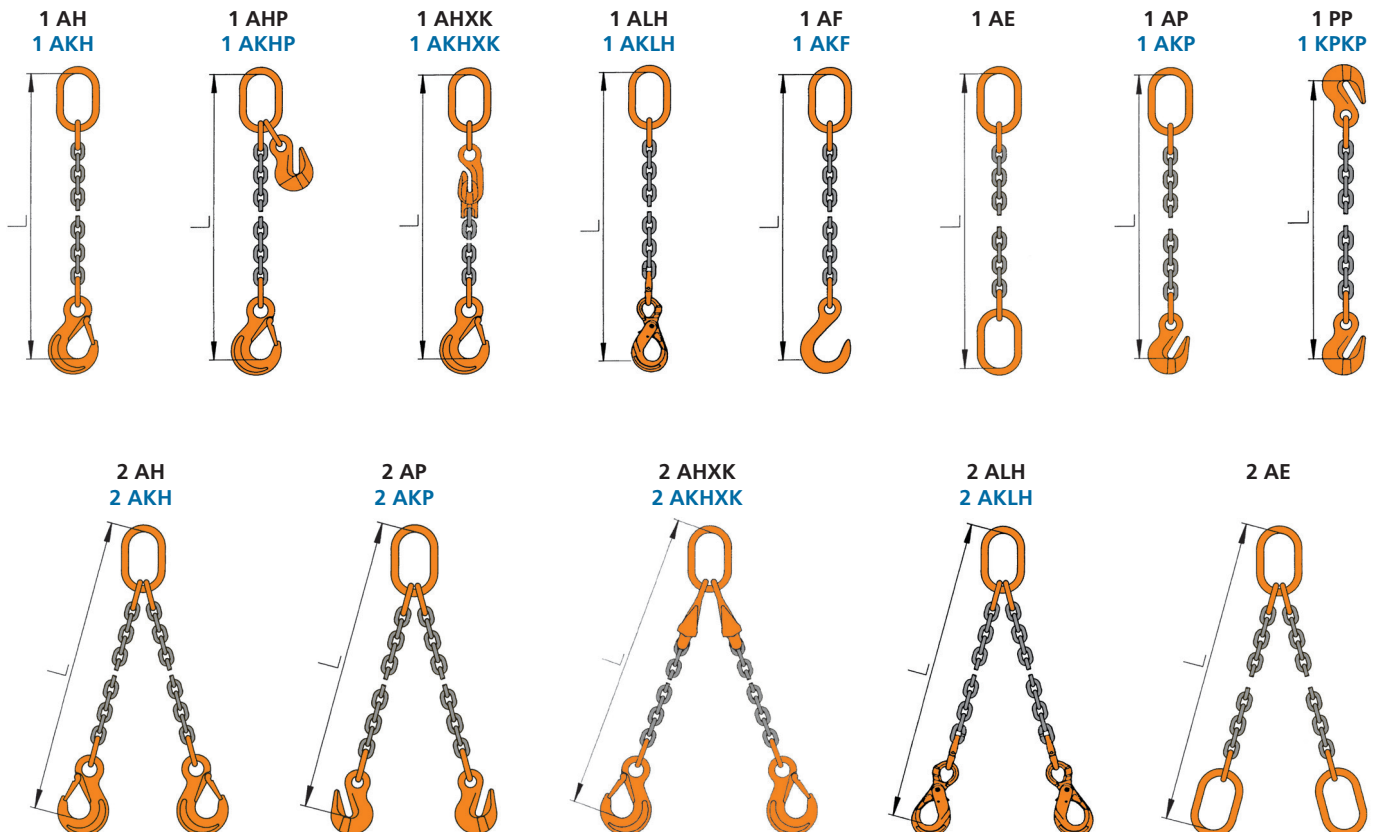

**Catene e accessori
Winner - Grado 10**

Winner chain and
accessory system in G10

BRACHE DI CATENA STANDARD
STANDARD CHAIN SLINGS

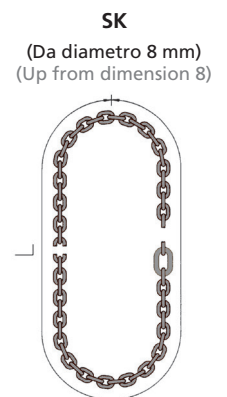
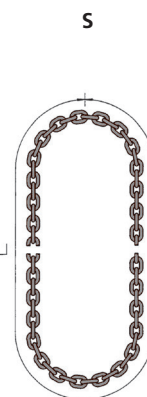
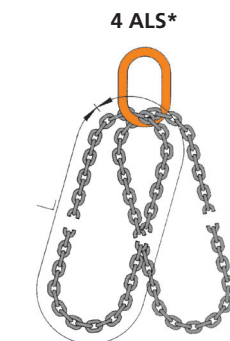
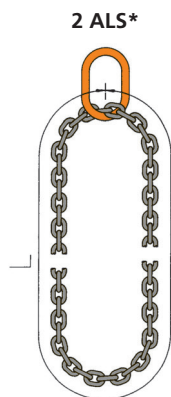
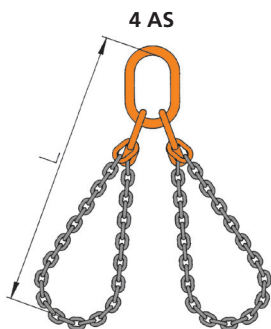
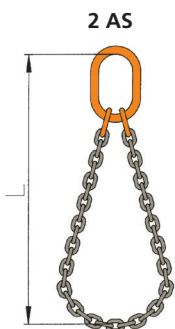
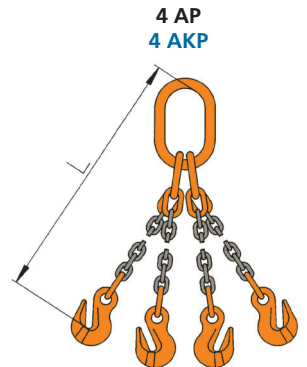
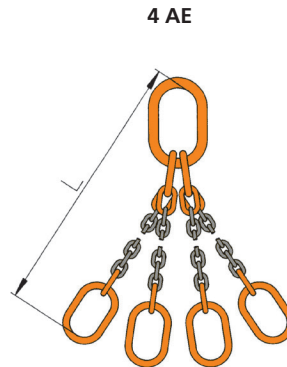
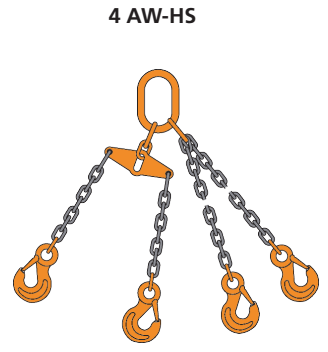
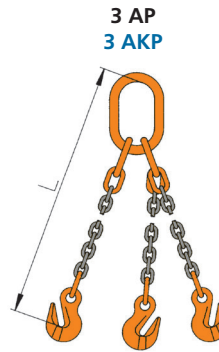
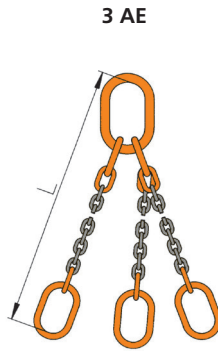
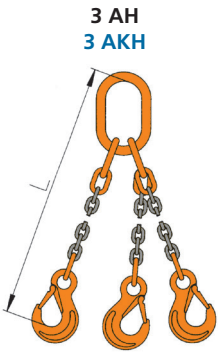
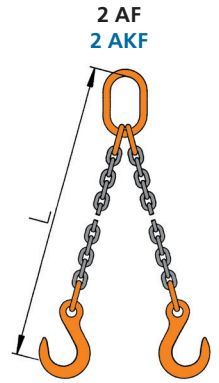
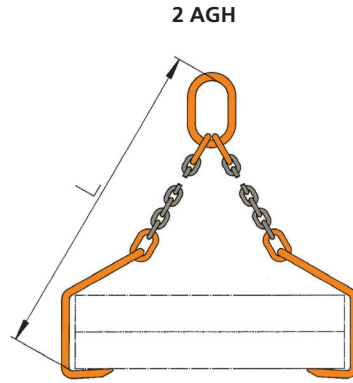
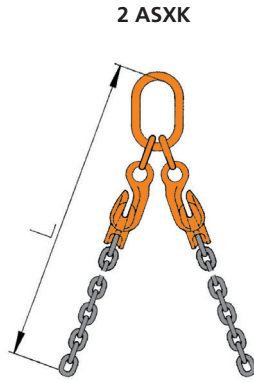
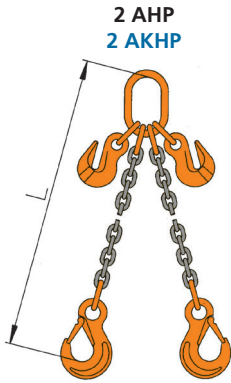
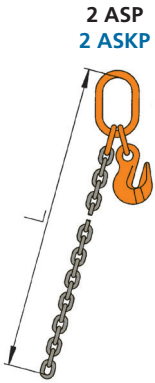

* Riduzione di portata
* Load reduction