

GF4C

Rotary limit switch



Rotary limit switch used to control and measure the movement of industrial machines or the position of the nacelle or pitch angle of wind turbines.

FEATURES

- It consists of a gear motor that transfers movement to the cams and the other movement detection devices through a primary input reduction stage (worm gear and helical toothed gear) and one or more secondary output stages.
- Accurate adjustment of cams by means of screws.
- Positive opening NC contacts for safety functions.
- Mechanical life of switches: up to 1 million operations.
- IP protection degree: GF4C is classified IP65.
- Extreme temperature resistance: -25°C to +70°C.
- It features transmission and gear driving shafts made of stainless steel, self-lubricating technopolymer gears and driving bushes and sintered bronze bushes moulded into the base of the limit switch to prevent rubbing against plastic material.
- All materials and components used are wear resistant and guarantee protection of the unit against water and dust.

OPTIONS

- Revolution ratios from 1:1 to 1:969, achieved by combining different secondary output stages.
- Each of the two outputs can be set to a different revolution ratio to enable diversified control of the machine when special requirements need to be met.
- Snap actions switches with 1NO+1NC contacts or slow action switches with 1NC contact.
- It can be equipped with 2 cam sets (with up to 7 switches), potentiometers and encoders (alone or on top of cam sets with up to 2 switches) and Yankee absolute encoders (on top of cam sets with up to 3 switches).
- Available with flanges, pinion gears and couplings.
- Available with direct control switches to enable direct action on the motor.

CERTIFICATIONS

- CE marking and cULus* marking

Fill in the "request form" for accurate product configuration.

* Not available on all versions.



CERTIFICATIONS

Conformity to Community Directives	2014/35/UE Low Voltage Directive
	2006/42/CE Machinery Directive
Conformity to CE Standards	EN 60204-1 Safety of machinery - Electrical equipment of machines
	EN 60947-1 Low-voltage switchgear and controlgear
	EN 60947-5-1 Low-voltage switchgear and controlgear - Control circuit devices and switching elements - Electromechanical control circuit devices
	EN 60529 Degrees of protection provided by enclosures
Conformity to cULus Standards	CSA-C22.2 No 14-13 Industrial Control Equipment
	UL 508 Industrial Control Equipment
Markings and homologations	CE cULus*



GENERAL TECHNICAL SPECIFICATIONS

Ambient temperature	Storage -40°C/+70°C
	Operational -25°C/+70°C
IP protection degree	IP 65
Insulation category	Class II
Cable entry	Cable clamp M20
Shafts	Stainless steel AISI 303

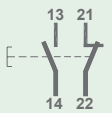
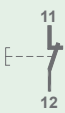
TECHNICAL SPECIFICATIONS OF THE SWITCHES FOR AUXILIARY CONTROL

Code	PRSL0036XX	PRSL0037XX
Utilisation category	AC 15	
Rated operational voltage	3 A	
Rated operational current	250 Vac	
Rated thermal current	10 A	
Rated insulation voltage	300 Vac	
Mechanical life	1x10 ⁶ operations	
Connections	Screw-type terminals	
Wires	1x2,5 mm ² , 2x1,5 mm ² (UL (c)UL: use 60°C or 75°C copper (CU) conductors and wire 16-18 AWG)	
Tightening torque	0,8 Nm	
Switch type	Double break, snap action	Double break, slow action
Contacts	1NO+1NC (All NC contacts are of the positive opening operation type )	1NC (All NC contacts are of the positive opening operation type )
Scheme		
Markings and homologations	CE cULus EAC	

* Not available on all versions.

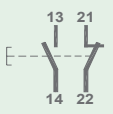
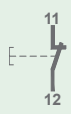
Code	PRSL0110XX	PRSL0111XX
Utilisation category	AC 15	
Rated operational voltage	250 Vac	
Rated operational current	3 A	
Rated thermal current	10 A	
Rated insulation voltage	300 Vac	
Mechanical life	10x10 ⁶ operations	
Connections	Screw-type terminals	
Wires	1x2.5 mm ² , 2x1.5 mm ² (UL (c)UL: use 60°C or 75°C copper (CU) conductors and stiff or flexible wire 14-22 AWG)	
Tightening torque	0.5 Nm	
Switch type	Double break, snap action	Double break, slow action
Contacts	1NO+1NC (All NC contacts are of the positive opening operation type )	1NC (All NC contacts are of the positive opening operation type )
Scheme		
Markings and homologations	CE cULus ENEC	

TECHNICAL SPECIFICATIONS OF THE SWITCHES FOR DIRECT CONTROL

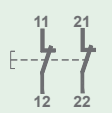
Code	PRSL0455PI
Utilisation category	AC 3
Rated operational current	400 Vac
Rated operational voltage	10 A
Rated thermal current	20 A
Rated insulation voltage	660 Vac
Mechanical life	1x10 ⁶ operations
Connections	Screw-type terminals
Wires	2x1.5 mm ² , 1x2.5 mm ²
Tightening torque	0.8 Nm
Switch type	Two-pole
Contacts	2NC
Scheme	
Markings and homologations	CE

TECHNICAL SPECIFICATIONS OF THE POTENTIOMETERS

Code of potentiometer with support	PA020001	PA020002
Ohmic value	10 k Ω	10 k Ω mechanical stop
Resolution	Infinite	
Independant linearity	$\pm 1\%$	
Life time	10x10 ⁶ movements	
Operational ambient temperature	-55°C/+105°C	
Continuos rotation (without stop)	360°	
Continuos rotation (with stop)	333° $\pm 5^\circ$	
Actual electrical angle	310° $\pm 5^\circ$	
Ohmic value tolerance	$\pm 20\%$	

Code of potentiometer with support	PA020006	PA020007	PA020008
Ohmic value	4.7 k Ω	10 k Ω	2.2 k Ω
Independant linearity (ref. AEA -3°)	$\pm 0,25\%$		
Life time	3x10 ⁶ movements		
Operational ambient temperature	-55°C/+125°C		
Mechanical angle	360° continuous		
Actual Electrical Angle (AEA)	355° $\pm 5^\circ$		
Ohmic value tolerance	$\pm 5\%$		
Temperature drift	< 50 PPM/°C		

Code of potentiometer with support	PA020003	PA020004	PA020005
Ohmic value	10 k Ω	10 k Ω	5 k Ω
Connections	4 turrets	3 turrets	4 turrets
Independant linearity (over AEA -3°)	$\leq \pm 1\%$	$\leq \pm 0.35\%$	$\leq \pm 1\%$
Life time	5x10 ⁶ movements		
Operational ambient temperature	-55°C/+125°C		
Mechanical angle	360° continuous		
Actual Electrical Angle (AEA)	340° $\pm 5^\circ$		
Ohmic value tolerance	Max $\pm 20\%$ at 20°C	Max $\pm 10\%$ at 20°C	Max $\pm 20\%$ at 20°C

Code of potentiometer with support	PA020009
Ohmic value	2 k Ω
Resolution	Better then 0.008°
Linearity	$\pm 0.075\%$
Independant linearity	$\pm 0.075\%$
Life time	100x10 ⁶ movements
Operational ambient temperature	-40°C/+100°C
Mechanical angle	360° continuous
Actual electrical travel	350° $\pm 2^\circ$
Ohmic value tolerance	$\pm 20\%$

TECHNICAL SPECIFICATIONS OF THE ENCODERS

Code with support	PA030001	PA030002
Resolution	36 pulses/rev.	150 pulses/rev.
Operational ambient temperature	-40°C/+85°C	
Code	Incremental	
Supply voltage	4.5 Vdc min. to 30 Vdc max. (35 mA max. - no load)	
Output voltage	Low: 500 mV max. at 10 mA High: (Vin - 0.6) at -10 mA (Vin - 1.3) at -25 mA	
Output current	25 mA max. load per output channel	
Output format	Two channel (A, B) quadrature with Index (Z)	
Phase sense	A leads B clockwise (CW) from the mounting end of the encoder	
Accuracy	+/- 0.8 arc-min.	
Outputs	Push pull	
Electrical protection	Protection against reverse polarity and output short-circuit	

CERTIFICATIONS OF THE ABSOLUTE ENCODER YANKEE

Conformity to Community Directives	2014/30/UE Electromagnetic Compatibility (EMC) Directive
	2006/42/CE Machinery Directive
	2014/35/UE Low Voltage Directive (LVD)
Conformity to CE Standards	EN 61326-1 Electrical equipment for measurement, control and laboratory use - EMC requirements
	EN 60529 Degrees of protection provided by enclosures
Conformity to cULus Standards	CSA-C22.2 No 14-13 Industrial Control Equipment
	UL 508 Industrial Control Equipment
Markings and homologations	CE 

GENERAL TECHNICAL SPECIFICATIONS OF THE ABSOLUTE ENCODER YANKEE

Ambient temperature	Storage -40°C/+80°C
	Operational -40°C/+80°C
IP protection degree	IP 20
Free rotation	360°
Maximum rotation speed	800 rpm

ELECTRICAL SPECIFICATIONS OF THE ABSOLUTE ENCODER YANKEE

Code	PA01AA01	PA01AB01	PA01AC01
Analog output	Current 4 ÷ 20 mA	Voltage 0 ÷ 10 V	PWM 0 ÷ 100 %
Power supply	12 ÷ 48 Vdc/12 ÷ 48 Vac		
Protection against reverse polarity	Yes		
Absorption	50 mA		
Resolution	12 bit		
Linearity	+/-0.5°		
Max. hysteresis	0.1°		
Zero Point setting	Through button/wire		
Signal increment direction	CW (standard)/CCW (on request)		
Connections	Terminal board		
Terminal wires	0.14 mm ² - 1.5 mm ²		
Terminal tightening torque	0.22 Nm - 0.25 Nm		

OVERALL DIMENSIONS (mm)

Standard

4

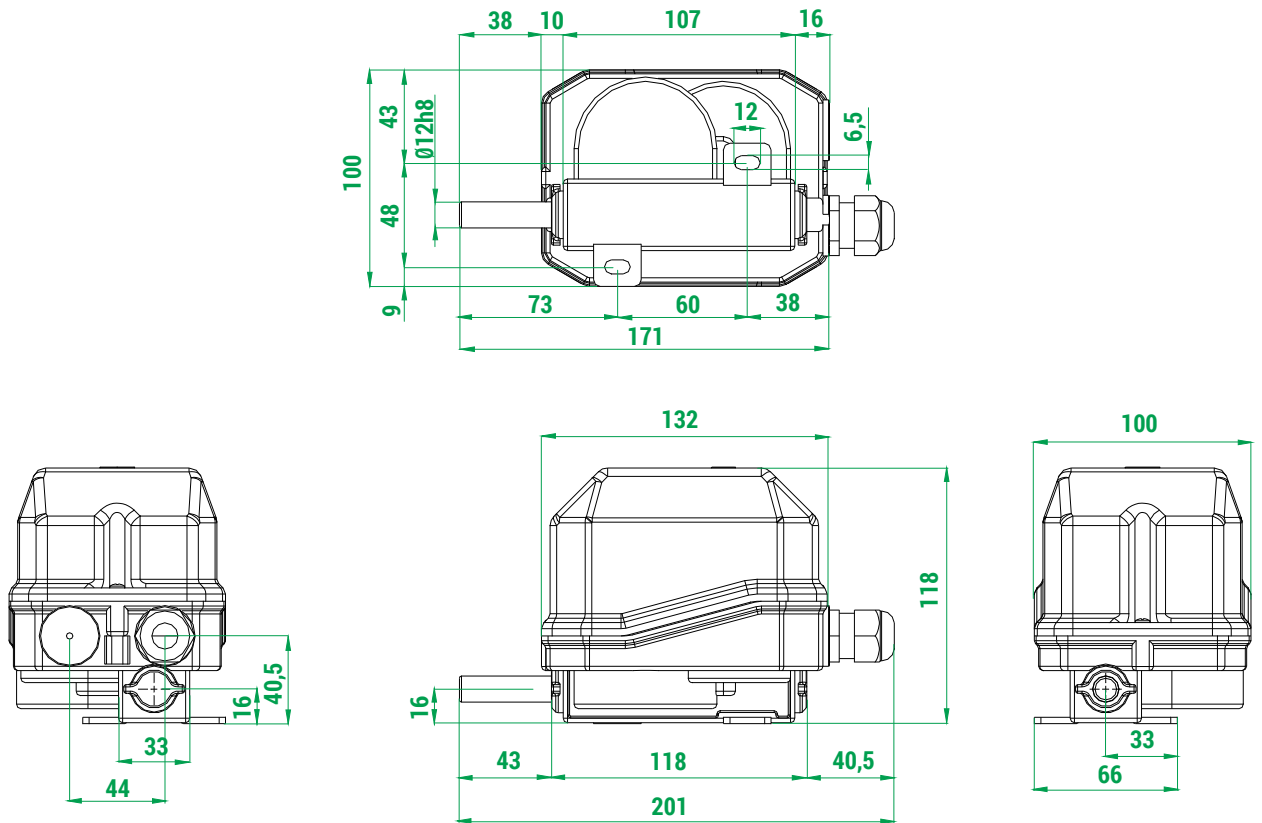

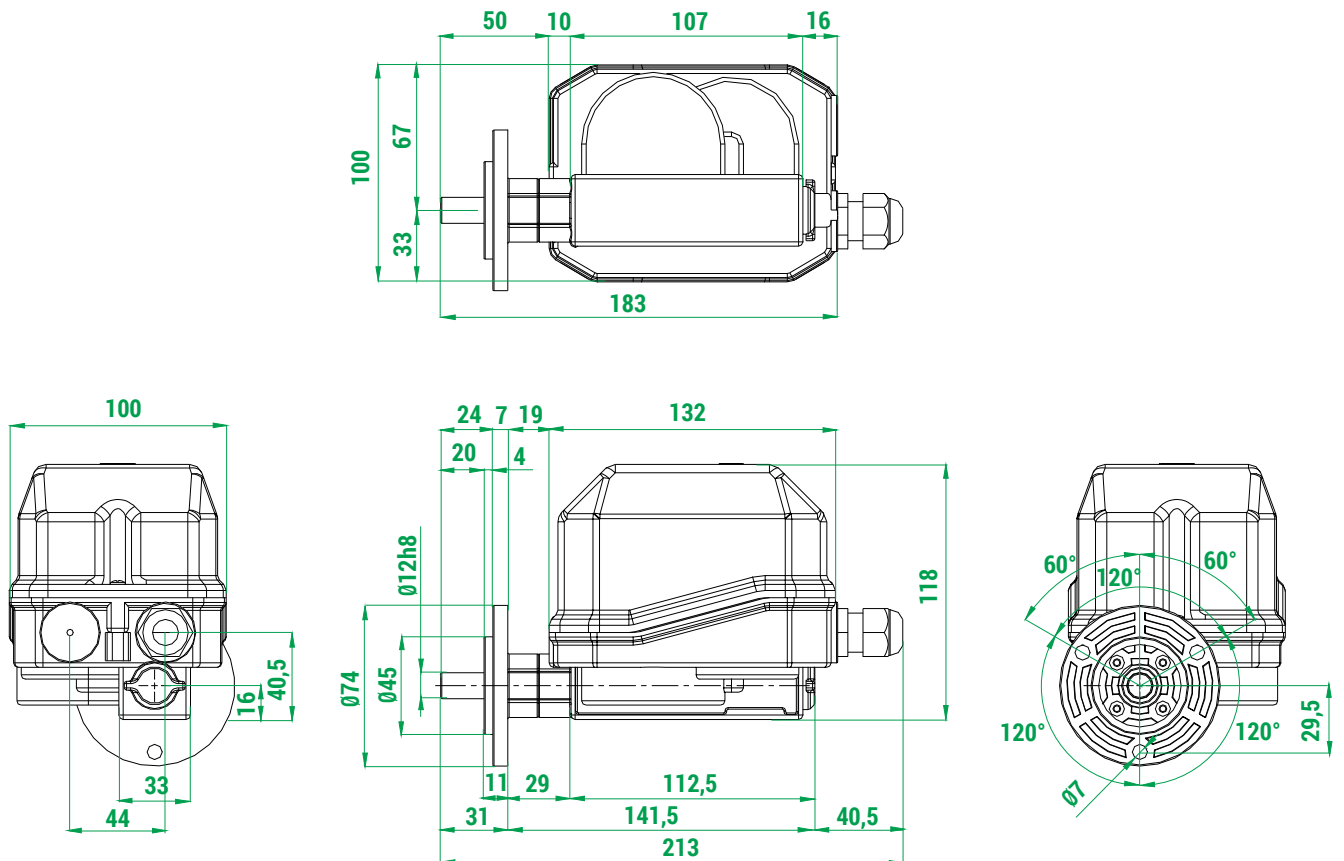

With flange



STANDARD LIMIT SWITCHES

Standard limit switches are equipped with cams PRSL7140PI 

Rated revolution ratio	No. of cams and switches	Switches	
		PRSL0036XX 1NO+1NC 	PRSL0037XX 1NC 
		Code	Code
1:1	2	PF090300010003	PF090300010004
	3	PF090300010002	PF090300010005
	4	PF090300010001	PF090300010006
1:5	2	PF090300050002	PF090300050004
	3	PF090300050003	PF090300050005
	4	PF090300050001	PF090300050006
1:10	2	PF090300100003	PF090300100005
	3	PF090300100004	PF090300100006
	4	PF090300100002	PF090300100007
1:15	2	PF090300150004	PF090300150007
	3	PF090300150003	PF090300150008
	4	PF090300150002	PF090300150001
1:20	2	PF090300200002	PF090300200004
	3	PF090300200003	PF090300200005
	4	PF090300200001	PF090300200006
1:25	2	PF090300250006	PF090300250007
	3	PF090300250003	PF090300250008
	4	PF090300250001	PF090300250002
1:50	2	PF090300500002	PF090300500028
	3	PF090300500003	PF090300500017
	4	PF090300500006	PF090300500007
1:75	2	PF090300750007	PF090300750009
	3	PF090300750008	PF090300750010
	4	PF090300750004	PF090300750006
1:100	2	PF090301000002	PF090301000001
	3	PF090301000006	PF090301000013
	4	PF090301000003	PF090301000004
1:150	2	PF090301500002	PF090301500001
	3	PF090301500011	PF090301500009
	4	PF090301500008	PF090301500003
1:200	2	PF090302000006	PF090302000007
	3	PF090302000002	PF090302000004
	4	PF090302000003	PF090302000008
1:250	2	PF090302500003	PF090302500009
	3	PF090302500007	PF090302500010
	4	PF090302500008	PF090302500011
1:300	2	PF090303000004	PF090303000008
	3	PF090303000006	PF090303000009
	4	PF090303000007	PF090303000010

ASSEMBLY DRAWING

4

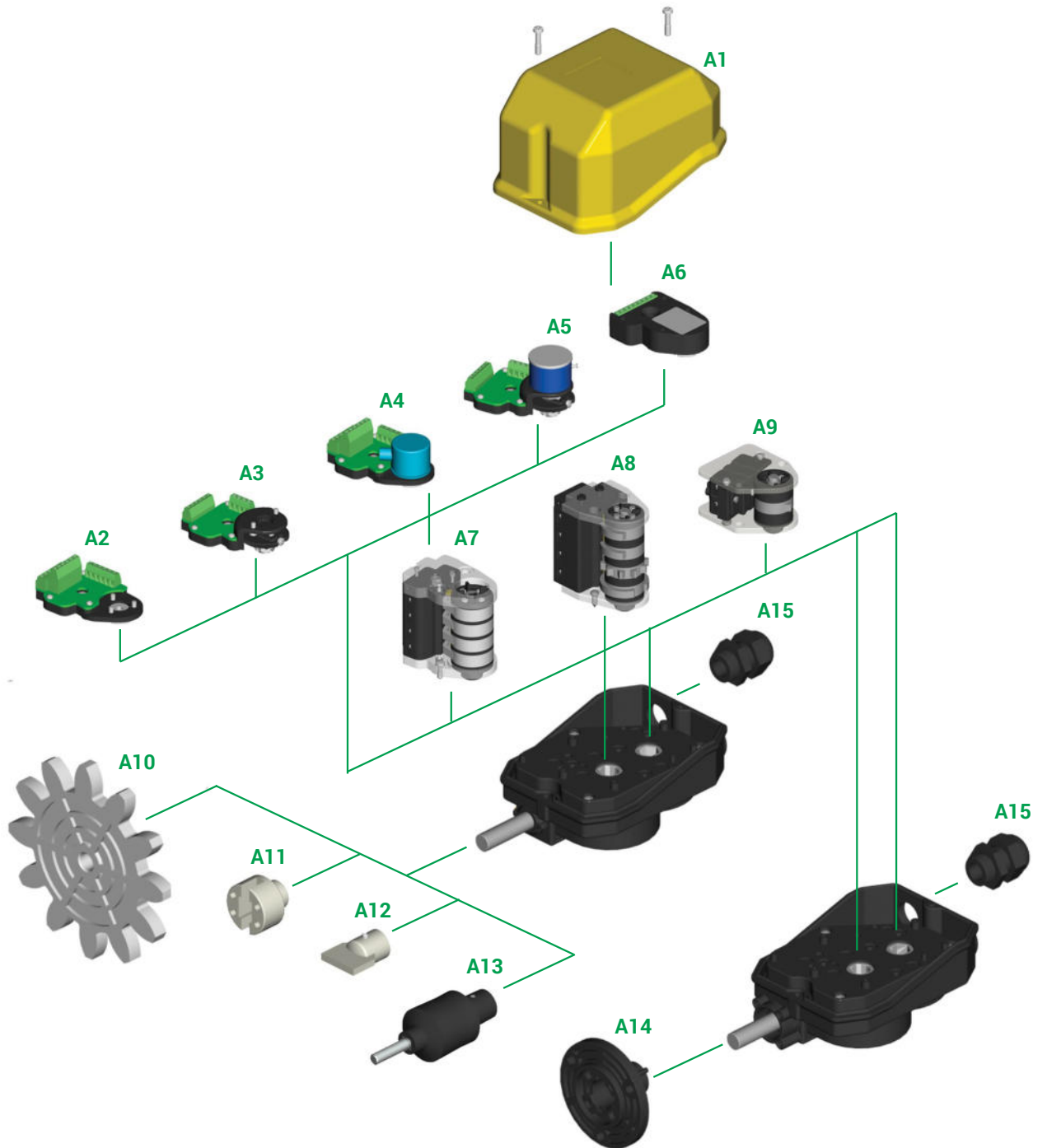

Refer to the following tables for descriptions of components: "Standard cam sets", "Potentiometers, encoders and sensors" and "Accessories".







COMPONENTS

Standard cam sets





Ref.	Drawing	No. and type of cams	No. and type of switches	Code
A7		2 cams A	2 switches PRSL0110XX	FCL20001
		2 cams A	2 switches PRSL0111XX	FCL20002
		Cams A+C	2 switches PRSL0110XX	FCL20003
		Cams A+C	2 switches PRSL0111XX	FCL20004
		2 cams C	2 switches PRSL0110XX	FCL20005
		2 cams C	2 switches PRSL0111XX	FCL20006
		Cams D+D+B+F	4 switches PRSL0110XX	FCL40001
		Cams D+D+B+F	4 switches PRSL0111XX	FCL40002
		4 cams A	4 switches PRSL0110XX	FCL40003
		4 cams A	4 switches PRSL0111XX	FCL40004
		Cams A+A+C+C	4 switches PRSL0110XX	FCL40005
		Cams A+A+C+C	4 switches PRSL0111XX	FCL40006
		4 cams C	4 switches PRSL0110XX	FCL40007
		4 cams C	4 switches PRSL0111XX	FCL40008
		Cams C+C+C+E	4 switches PRSL0110XX	FCL40009
		Cams C+C+C+E	4 switches PRSL0111XX	FCL40010
		Cams A+A+E+E	4 switches PRSL0110XX	FCL40011
		Cams A+A+E+E	4 switches PRSL0111XX	FCL40012
A8		2 cams A	2 switches PRSL0036XX	PRFC0010PE
		2 cams A	2 switches PRSL0037XX	PRFC0011PE
		2 cams C	2 switches PRSL0036XX	PRFC0012PE
		2 cams C	2 switches PRSL0037XX	PRFC0013PE
		3 cams A	3 switches PRSL0036XX	PRFC0020PE
		3 cams A	3 switches PRSL0037XX	PRFC0021PE
		3 cams C	3 switches PRSL0036XX	PRFC0022PE
		3 cams C	3 switches PRSL0037XX	PRFC0024PE
		4 cams A	4 switches PRSL0036XX	PRFC0030PE
		4 cams A	4 switches PRSL0037XX	PRFC0031PE
		4 cams C	4 switches PRSL0036XX	PRFC0032PE
		4 cams C	4 switches PRSL0037XX	PRFC0034PE
A9		1 cam A	1 interruttore PRSL0455PI	PRFC0101PE
		2 cam A	2 switches PRSL0455PI	PRFC0103PE

Other sets with 2/3/4 switches PRSL0036XX/PRSL0037XX/PRSL0110XX/PRSL0111XX or with 1 or 2 switches PRSL0455PI are available on request.





Cam reference chart for sets with switches PRSL0110XX and PRSL0111XX

Cam			Code	Switching angle with PRSL0110XX	Switching angle with PRSL0111XX
A		1 point	PRSL7194PI	21,5° ±0,5°	23,0° ±0,5°
B		10 points	PRSL7193PI	21,5° ±0,5°	23,0° ±0,5°
C		60° sector	PRSL7195PI	82,0° ±0,5°	86,0° ±0,5°
D		72° sector	PRSL7196PI	94,0° ±0,5°	97,5° ±0,5°
E		180° sector	PRSL7191PI	204,5° ±0,5°	203,0° ±0,5°
F		305° sector	PRSL7192PI	328,5° ±0,5°	327,0° ±0,5°

Cam reference chart for sets with switches PRSL0036XX, PRSL0037XX and PRSL0455PI

Cam			Code	Switching angle with PRSL036XX	Switching angle with PRSL037XX
A		1 point	PRSL7140PI	21,0° ±0,5°	25,0° ±0,5°
B		10 points	PRSL7142PI	16,5° ±0,5°	21,5° ±0,5°
C		60° sector	PRSL7141PI	80,0° ±0,5°	86,0° ±0,5°
E		180° sector	PRSL7144PI	199,5° ±0,5°	205,5° ±0,5°
H		335° sector	PRSL7143PI	343,5° ±0,5°	349,0° ±0,5°







Potentiometers, encoders and sensors

Ref.	Drawing	Description	Code
A2		Support for encoder	PA030000
A3		Support for potentiometer	PA020000
A4		Encoder 36 pulses./rev. with support	PA030001
		Encoder 150 pulses./rev. with support	PA030002
A5		Potentiometer 10 kΩ with support	PA020001
		Potentiometer 10 kΩ mechanical stop with support	PA020002
		Potentiometer 10 kΩ ±10% 4 pins with support	PA020003
		Potentiometer 10 kΩ ±10% 3 pins with support	PA020004
		Potentiometer 5 kΩ ±10% with support	PA020005
		Potentiometer 4.7 kΩ with support	PA020006
		Potentiometer 10 kΩ with support	PA020007
Potentiometer 2.2 kΩ with support	PA020008		
		Potentiometer 2KΩ with support	PA020009

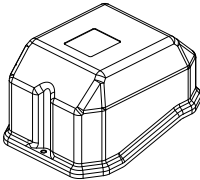
Potentiometers, encoders and sensors

A6		Absolute encoder Yankee - current output	PA01AA01
		Absolute encoder Yankee - voltage output	PA01AB01
		Absolute encoder Yankee - PWM output	PA01AC01

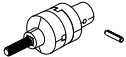
Accessories

Ref.	Drawing	Description	Code
A1		Cover	PRSL5582PI
A10		Pinion gear	See pinion gear tables
A11		Female coupling with pin	PRSL0920PI
A12		Male coupling with pin	PRSL0919PI
A13		Coupling with pin	PRSL0981PI
A14		Flange with pin	PRSL0947PI
A15		Cable clamp M20	PRPS0064PE

Moulded pinion gears

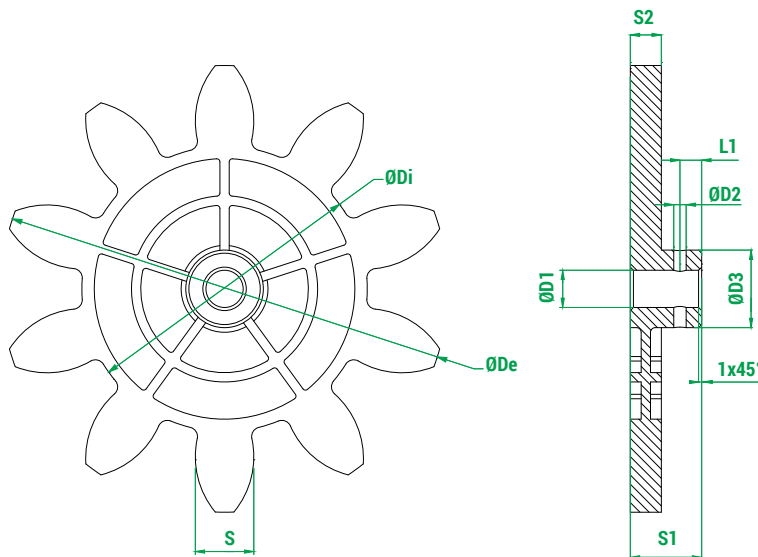

Legend

Z Number of teeth

M Module

Dp Primitive diameter

De External diameter

Di Internal diameter

a Addendum

d Dedendum

Alpha Pressure angle

Code	Z	M	Dp	De	Di	a	d	S	Alpha	D1	D2	D3	S1	S2	L1
PRSL0915PI	8	20.00	160.00	200.00	113.20	20.00	23.40	31.41	20.00	12.00	4.00	24.00	23.00	10.00	7.00
PRSL0912PI	10	12.00	120.00	144.00	92.00	12.00	14.00	18.85	20.00	12.00	4.00	25.00	23.00	10.00	7.00
PRSL0913PI	10	14.00	140.00	168.00	107.24	14.00	16.38	21.99	20.00	12.00	4.00	24.60	23.00	10.00	7.00
PRSL0914PI	10	16.00	160.00	192.00	122.67	16.00	18.67	25.13	20.00	12.00	4.00	24.00	23.00	10.00	7.00
PRSL0917PI	11	6.00	66.00	78.00	51.96	6.00	7.02	9.42	20.00	12.00	4.00	19.00	23.00	8.00	7.00
PRSL0916PI	12	5.00	60.00	70.00	48.30	5.00	5.83	7.85	20.00	12.00	4.00	20.00	23.00	8.00	7.00
PRSL0918PI	12	8.00	96.00	112.00	77.28	8.00	9.36	12.56	20.00	12.00	3.90	21.50	23.50	10.00	7.00
PRSL0911PI	12	10.00	120.00	140.00	96.67	10.00	11.67	15.71	20.00	12.00	4.00	25.00	23.50	10.00	7.00
PRSL0944PI	12	12.00	144.00	168.00	116.00	12.00	14.00	18.85	20.00	12.00	4.00	24.00	23.00	10.00	7.00

Measuring unit: mm.

Waterjet cut pinion gears

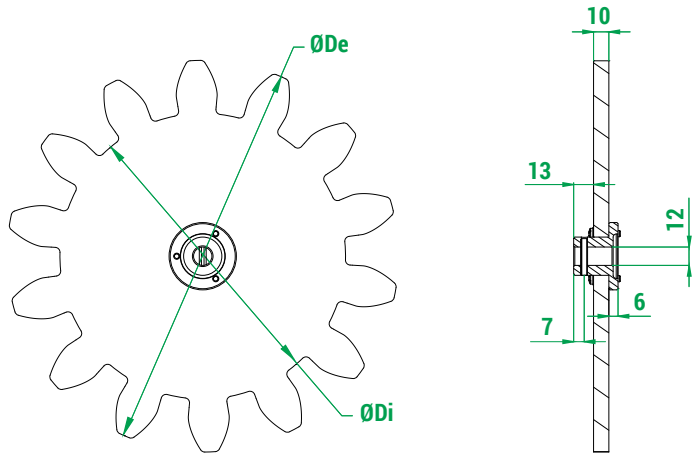

Legend

Z	Number of teeth
M	Module
Dp	Primitive diameter
De	External diameter
Di	Internal diameter
a	Addendum
d	Dedendum
Alpha	Pressure angle

Code	Z	M	Dp	De	Di	a	d	Alpha
PRSL0857PI	8	18.00	144.00	180.00	102.00	18.00	21.00	20.00
PRSL0855PI	8	24.00	192.00	240.00	136.00	24.00	28.00	20.00
PRSL0992PI	9	10.00	90.00	110.00	66.67	10.00	11.67	20.00
PRSL0879PI	9	16.00	144.00	176.00	106.67	16.00	18.67	20.00
PRSL0854PI	9	18.00	162.00	198.00	120.00	18.00	21.00	20.00
PRSL0871PI	9	20.00	180.00	220.00	133.33	20.00	23.33	20.00
PRSL0849PI	9	24.00	216.00	264.00	160.00	24.00	28.00	20.00
PRSL0846PI	10	10.00	100.00	120.00	76.67	10.00	11.67	20.00
PRSL0993PI	10	18.00	180.00	216.00	138.00	18.00	21.00	20.00
PRSL0970PI	10	22.00	220.00	264.00	168.52	22.00	25.74	20.00
PRSL0856PI	10	24.00	240.00	288.00	184.00	24.00	28.00	20.00
PRSL0861PI	11	12.00	132.00	156.00	104.00	12.00	14.00	20.00
PRSL0998PI	11	18.00	198.00	234.00	156.00	18.00	21.00	20.00
PRSL0997PI	11	20.00	220.00	260.00	173.36	20.00	23.32	20.00
PRSL0859PI	11	24.00	264.00	312.00	204.00	24.00	30.00	20.00
PRSL0863PI	12	14.00	168.00	196.00	133.00	14.00	17.50	20.00
PRSL0897PI	12	16.00	192.00	224.00	154.67	16.00	18.67	20.00
PRSL0972PI	12	18.00	216.00	252.00	173.88	18.00	21.06	20.00
PRSL0845PI	12	20.00	240.00	280.00	193.34	20.00	23.32	20.00
PRSL0878PI	12	24.00	288.00	336.00	232.00	24.00	28.00	20.00
PRSL0860PI	13	6.00	78.00	90.00	63.00	6.00	7.50	20.00
PRSL0853PI	13	12.00	156.00	178.59	126.00	11.29	15.00	20.00
PRSL0898PI	13	16.00	208.00	240.00	170.67	16.00	18.66	20.00
PRSL0862PI	14	10.00	140.00	169.00	125.00	15.00	7.50	20.00
PRSL0896PI	14	16.00	224.00	256.00	186.67	16.00	18.67	20.00
PRSL0999PI	14	18.00	252.00	288.00	210.00	18.00	21.00	20.00
PRSL0848PI	14	20.00	280.00	320.00	233.33	20.00	23.33	20.00
PRSL0858PI	15	18.00	270.00	306.00	228.00	18.00	21.00	20.00
PRSL0847PI	16	20.00	320.00	360.00	273.33	20.00	23.33	20.00
PRSL0973PI	17	10.00	170.00	190.00	145.00	10.00	12.50	22.89
PRSL0974PI	17	14.00	238.00	266.00	203.00	14.00	17.50	22.89
PRSL0851PI	20	6.00	120.00	132.00	105.00	6.00	7.50	22.89
PRSL0844PI	25	1.00	25.00	27.00	22.50	1.00	1.25	22.89

Measuring unit: mm.

GF4C - REQUEST FORM FOR NON STANDARD LIMIT SWITCH

4

Instructions

(See next pages for list of components and legends)

- 1 Version:** tick the required version.
- 2 Revolution ratio:** write the required revolution ratio for each output.
 ATTENTION: refer to table "Configurations with sets of cams/ switches" for possible configurations.
- 3 Standard cam sets:** write the code of the cam set required for each output.
 ATTENTION: refer to table "Configurations with sets of cams/ switches" for possible configurations.
- 4 Customized cam sets:** for non standard cam sets, fill in the scheme choosing the cams and the switches required.
 ATTENTION: refer to table "Configurations with sets of cams/ switches" for possible configurations.
 Customized cams are available on request.
- 5 Potentiometers, encoders, Yankee:** write the code of the potentiometer, encoder or Yankee required. Refer to table "Configurations with potentiometers, encoders and Yankee" for possible configurations.
- 6 Cable clamps:** choose the number of cable clamps required.
- 7 Coupling, flange, pinion gear:** tick the box when coupling, flange or pinion gear are required.
 When a standard pinion gear is required, write the code number listed in the pinion gear table in the catalogue.
 When a special pinion gear is required, write the number of teeth, the module and the primitive diameter.
- 8 Shaft:** tick the shaft type required.
 Customized shafts are available on request.

Customized cam sets 4

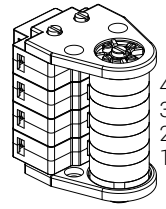

Output 1

Cam code	Switch code
4 _____	_____
3 _____	_____
2 _____	_____
1 _____	_____

Output 2

Cam code	Switch code
4 _____	_____
3 _____	_____
2 _____	_____
1 _____	_____

Potentiometers, encoders, Yankee 5

	Output 1	Output 2
Code	_____	_____

Version 1

- Version IP00 (without cover)
- Version IP65

Cable clamps 6

- No. 1 cable clamp M20
- No. 2 cable clamps M20

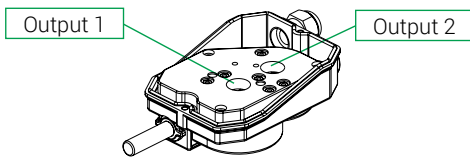

Revolution ratio 2

Output 1	Output 2
<input type="checkbox"/> 1:1 <input type="checkbox"/> 1:25 <input type="checkbox"/> 1:200 <input type="checkbox"/> 1:5 <input type="checkbox"/> 1:50 <input type="checkbox"/> 1:250 <input type="checkbox"/> 1:10 <input type="checkbox"/> 1:70 <input type="checkbox"/> 1:300 <input type="checkbox"/> 1:15 <input type="checkbox"/> 1:100 <input type="checkbox"/> 1:450 <input type="checkbox"/> 1:20 <input type="checkbox"/> 1:150 <input type="checkbox"/> 1: _____	1: _____ Not all revolution ratios are available

- Male coupling Coupling 7
- Female coupling Flange
- Pinion gear

Pinion gear code _____

Customized pinion gear

No. of teeth _____

Module _____

Primitive diameter _____

Standard cam sets 3

Cam set code

_____	Output 1
_____	Output 2

Standard shaft 8

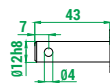

Flexible shaft

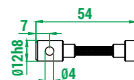

3 Legend - Standard cam sets

No. & type of switches	No. & type of cams	Code
2 x PRSL0036XX	2 cams A	PRFC0010PE
	2 cams C	PRFC0012PE
2 x PRSL0037XX	2 cams A	PRFC0011PE
	2 cams C	PRFC0013PE
3 x PRSL0036XX	3 cams A	PRFC0020PE
	3 cams C	PRFC0022PE
3 x PRSL0037XX	3 cams A	PRFC0021PE
	3 cams C	PRFC0024PE
4 x PRSL0036XX	4 cams A	PRFC0030PE
	4 cams C	PRFC0032PE
4 x PRSL0037XX	4 cams A	PRFC0031PE
	4 cams C	PRFC0034PE
2 x PRSL0110XX	2 cams A	FCL20001
	Cams A+C	FCL20003
	2 cams C	FCL20005
4 x PRSL0110XX	Cams D+D+B+F	FCL40001
	4 cams A	FCL40003
	Cams A+A+C+C	FCL40005
	4 cams C	FCL40007
	Cams C+C+C+E	FCL40009
	Cams A+A+E+E	FCL40011
2 x PRSL0111XX	2 cams A	FCL20002
	Cams A+C	FCL20004
4 x PRSL0111XX	2 cams C	FCL20006
	Cams D+D+B+F	FCL40002
	4 cams A	FCL40004
	Cams A+A+C+C	FCL40006
	4 cams C	FCL40008
	Cams C+C+C+E	FCL40010
	Cams A+A+E+E	FCL40012
1 x PRSL0455XPI	1 cam A	PRFC0101PE
2 x PRSL0455XPI	2 cams A	PRFC0103PE

7 Legend - Potentiometers, encoders and Yankee

Description	Code
Potentiometer 10 kΩ with support	PA020001
Potentiometer 10 kΩ mechanical stop with support	PA020002
Potentiometer 10 kΩ ±10% 4 pins with support	PA020003
Potentiometer 10 kΩ ±10% 3 pins with support	PA020004
Potentiometer 5 kΩ ±10% with support	PA020005
Potentiometer 4,7 kΩ with support	PA020006
Potentiometer 10 kΩ with support	PA020007
Potentiometer 2,2 kΩ with support	PA020008
Potentiometer 2KΩ with support	PA020009
Encoder 36 pulses/rev. with support	PA030001
Encoder 150 pulses/rev. with support	PA030002
Yankee - current output	PA01AA01
Yankee - voltage output	PA01AB01
Yankee - PWM output	PA01AC01

4 Legend - Switches

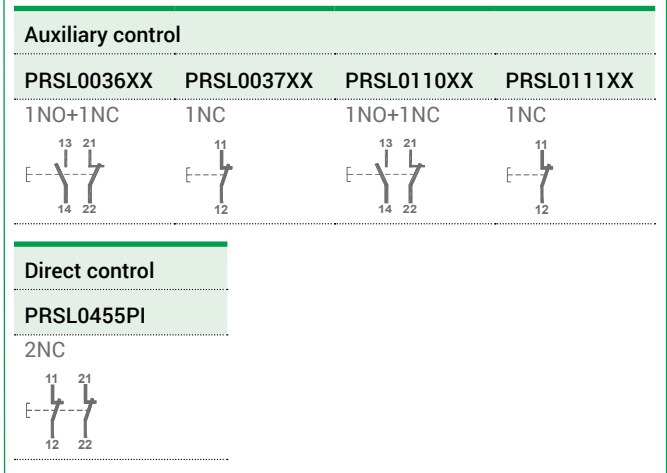

4 Legend - Standard cams

Cam			Code for switches PRSL0036XX, PRSL0037XX, PRFC0455PI	Switching angle with PRSL0036XX	Switching angle with PRSL0037XX	Code for switches PRSL0110XX, PRSL0111XX	Switching angle with PRSL0110XX	Switching angle with PRSL0111XX
A		1 point	PRSL7140PI	21,0° ±0,5°	25,0° ±0,5°	PRSL7194PI	21,5° ±0,5°	23,0° ±0,5°
B		10 points	PRSL7142PI	16,5° ±0,5°	21,5° ±0,5°	PRSL7193PI	21,5° ±0,5°	23,0° ±0,5°
C		60° sector	PRSL7141PI	80,0° ±0,5°	86,0° ±0,5°	PRSL7195PI	82,0° ±0,5°	86,0° ±0,5°
D		72° sector	/	/	/	PRSL7196PI	94,0° ±0,5°	97,5° ±0,5°
E		180° sector	PRSL7144PI	199,5° ±0,5°	205,5° ±0,5°	PRSL7191PI	204,5° ±0,5°	203,0° ±0,5°
F		305° sector	/	/	/	PRSL7192PI	328,5° ±0,5°	327,0° ±0,5°
H		335° sector	PRSL7143PI	343,5° ±0,5°	349,0° ±0,5°	/	/	/

4 Table - Configurations with sets of cams/switches

Sets of cams with switches PRSL0036XX and PRSL0037XX

When using sets of cams with switches PRSL0036XX and PRSL0037XX:

- it is possible to mount up to 4 switches on output 2
- it is possible to mount up to 3 switches on output 1.

It is possible to mount 4 switches on output 1 only when output 2 is left empty.

Sets of cams with switches PRSL0110XX and PRSL0111XX

When using sets of cams with switches PRSL0110XX and PRSL0111XX, it is possible to mount up to 4 switches on each output.

Sets of cams with switches PRSL0455PI

When using sets of cams with switches PRSL0455PI, it is possible to mount only 1 switch on each output.

It is possible to mount 2 switches on output 1 only when output 2 is left empty.

5 Table - Configurations with potentiometers, encoders and Yankee

With sets of cams/switches PRSL0036XX and PRSL0037XX

When using sets of cams with switches PRSL0036XX and PRSL0037XX, it is possible to mount potentiometers, encoders and Yankee only on the output where there is no set of cams/switches. It is not possible to mount potentiometers, encoders nor Yankee on top of a set of cams/switches.

* Potentiometers marked with * can be mounted on output 1 or on output 2, but the other output must be left empty.

With sets of cams/switches PRSL0110XX and PRSL0111XX

Potentiometers, encoders and Yankee can be mounted on output 1 and 2 alone (No. of switches = 0), or on top of a set of cams with switches PRSL0110XX and PRSL0111XX according to the possible configurations shown in the following table.

* Potentiometers marked with * can be mounted on output 1 or on output 2, but the other output must be left empty.

Potentiometers, encoders and Yankee	Output 1					Output 2				
	No. of switches PRSL0110XX-PRSL0111XX					No. of switches PRSL0110XX-PRSL0111XX				
	0	1	2	3	4	0	1	2	3	4
PA020001	YES	YES	NO	NO	NO	YES	YES	NO	NO	NO
PA020002	YES	YES	NO	NO	NO	YES	YES	NO	NO	NO
PA020003	YES	YES	YES	NO	NO	YES	YES	YES	NO	NO
PA020004	YES	YES	YES	NO	NO	YES	YES	YES	NO	NO
PA020005	YES	YES	YES	NO	NO	YES	YES	YES	NO	NO
PA020006*	YES	YES	NO	NO	NO	YES	YES	NO	NO	NO
PA020007*	YES	YES	NO	NO	NO	YES	YES	NO	NO	NO
PA020008*	YES	YES	NO	NO	NO	YES	YES	NO	NO	NO
PA020009*	YES	NO	NO	NO	NO	YES	NO	NO	NO	NO
PA030001	YES	YES	YES	NO	NO	YES	YES	YES	NO	NO
PA030002	YES	YES	YES	NO	NO	YES	YES	YES	NO	NO
PA01AA01	YES	YES	YES	YES	NO	YES	YES	YES	YES	NO
PA01AB01	YES	YES	YES	YES	NO	YES	YES	YES	YES	NO
PA01AC01	YES	YES	YES	YES	NO	YES	YES	YES	YES	NO