

Reflexions-Lichtschranke (Schaltabstand: 11 m)
Photo-electric sensor (Range: 36 ft)

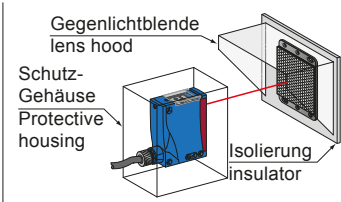

art 962293

Befestigung / Fixing

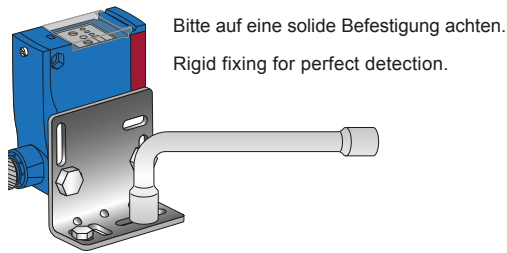
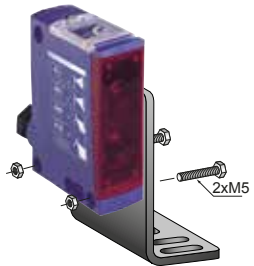

Außenmontage bitte nur mit Schutzgehäuse. Auf eine Isolierung gegen Frost ist zu achten um Kondenswasser auf optischen Teilen zu vermeiden.
Outdoor mounting with protective cover, on thermal insulator to avoid frost or condensation forming on the optical parts.

Abmessungen / Dimensions

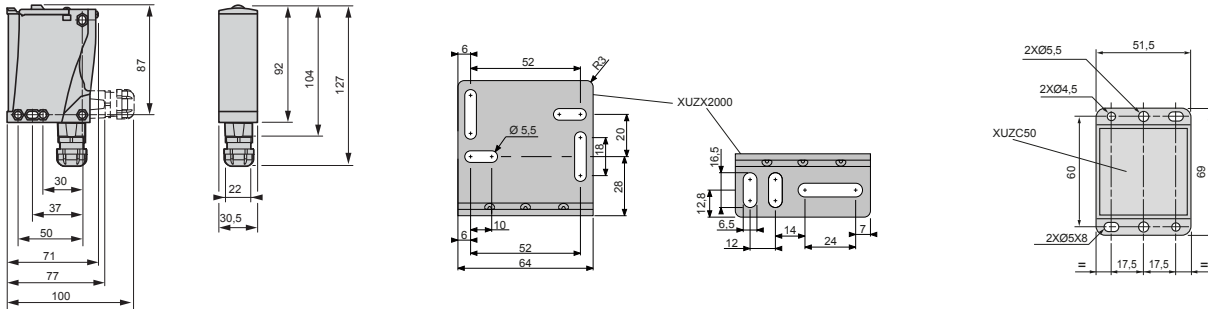

Anschlußplan / Wiring diagram

Klemme, T16-Version / Terminal block, T16 version

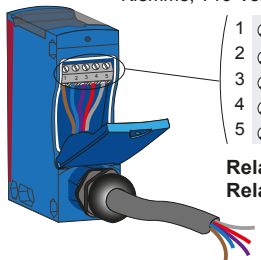

Relaisausgang / Relay output

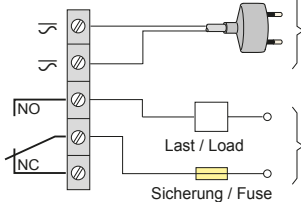

~ 24...240 V
Spannungsversorgung
Power Supply
~ 24...240 V
3 A: cos φ = 1
0,5 A: cos φ = 0,4
Last Load
Verbraucherspannung
Use
Sicherung / Fuse

Justierung / Alignment

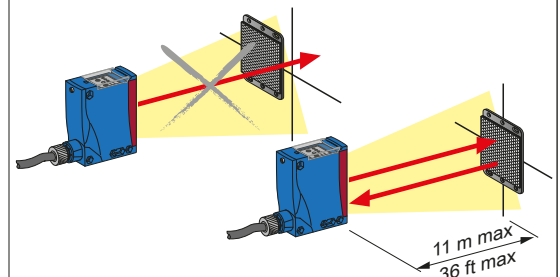

Funktion des Relais / Relay contacts operation

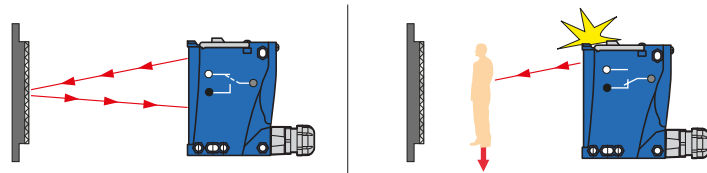

Ausgangssignal bei Erfassung / Signals a presence

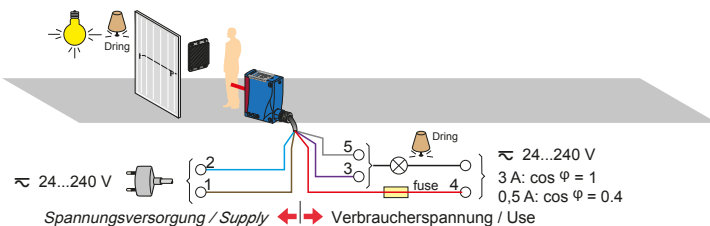

Schutzmaßnahmen / Protections

Betriebs-Temperatur : -25...+55 °C /
Operating temperature: -13...131 °F
Schutzart / Degree of protection: IP65

